



10/100/1000 BASE-T TRANSFORMER MODULE

P/N: XTFZ-LC13Z2ZB

Page : 1/4

Feature

- Compliant with IEEE 802.3 standard.
- DCR:1400mΩ Max
- Leakage Inductance:0.5uH Max@100KHz, 0.1V
- RoHS compliant.

Electrical Specifications @ 25°C					
Part Number	Turns Ratio (±5%)		OCL(μH Min) @ 100KHz/0.1V with 8.0mA DC	Cross talk (dB Min)	HI-POT (Vrms)
	TX	RX		1-100MHz	
XTFZ-LC13Z2ZB	1CT: 1CT	1CT: 1CT	350	-30	1500

Electrical Specifications @ 25°C							
Part Number	Insertion Loss (dB Max)	Return Loss (dB Min)					DCMR(dB Min) TX/RX
	1-100MHz	1-30MHz	40MHz	50MHz	60-80MHz	100MHz	1-100MHz
XTFZ-LC13Z2ZB	-1.1	-18	-14.4	-13.1	-12	-10	-30

* Operating temperature range: -40°C to +85°C. Storage temperature range: -40°C to +125°C.

Schematic

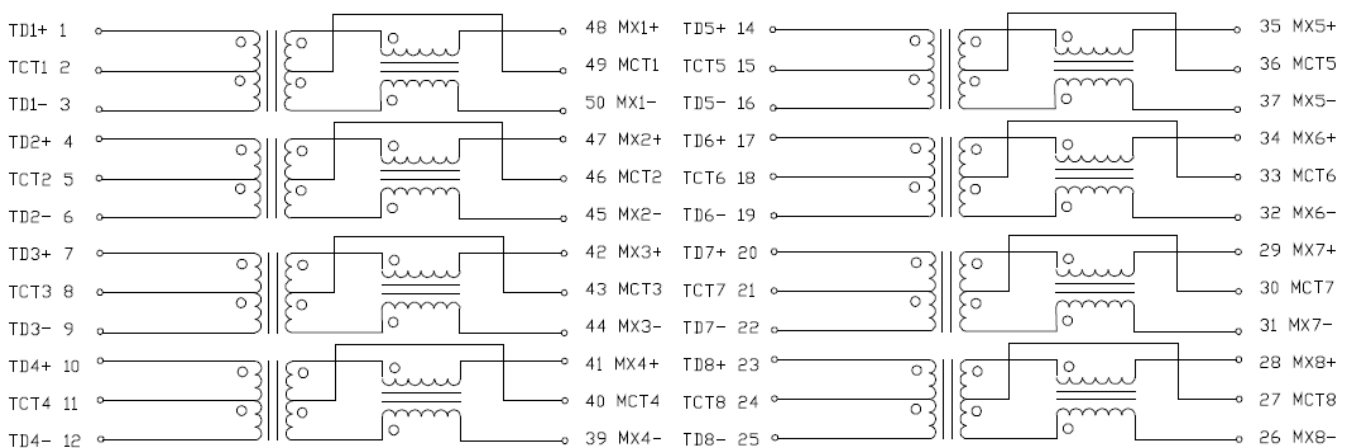



10/100/1000 BASE-T TRANSFORMER MODULE

P/N: XTFZ-LC13Z2ZB

Page : 2/4

Mechanical

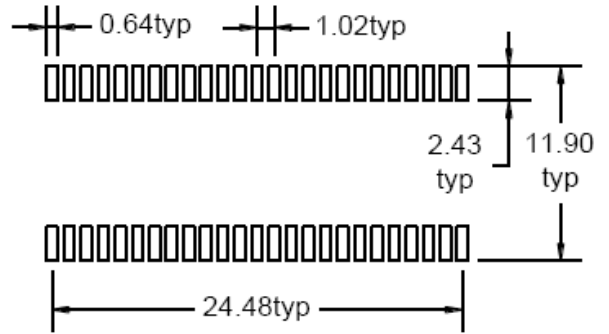
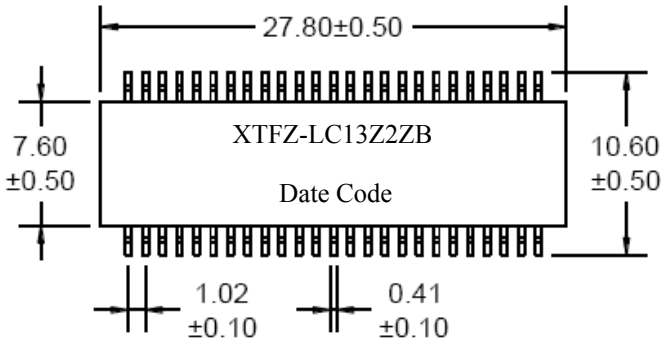

Suggested PAD Layout

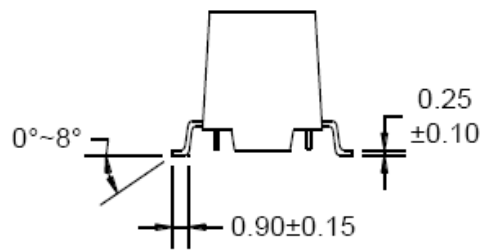
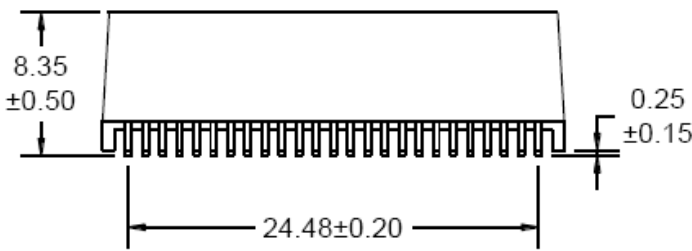

Units: mm.

Tolerance: ± 0.25 unless specified otherwise.



10/100/1000 BASE-T TRANSFORMER MODULE

P/N: XTFZ-LC13Z2ZB

Page : 3/4

Packing

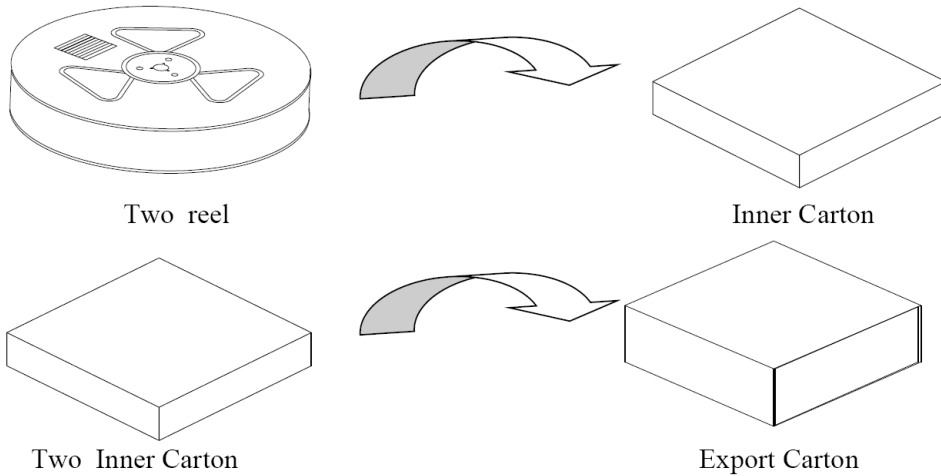
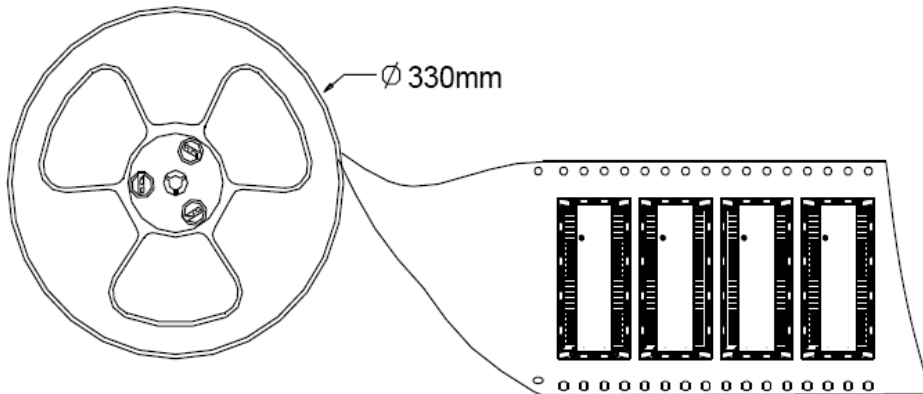
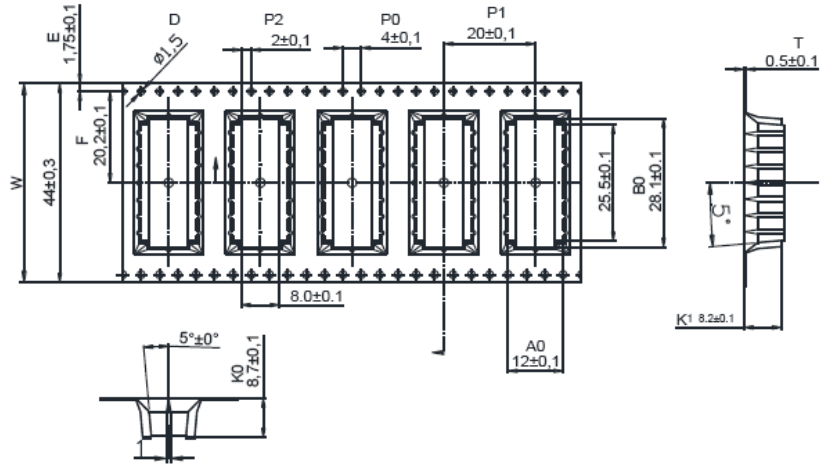



10/100/1000 BASE-T TRANSFORMER MODULE

P/N: XTFZ-LC13Z2ZB

Page : 4/4

Package Quantity:

One Reel=400

One Inner Carton=400*2=800Pcs

One Export Carton=800*2=1600Pcs