

1 2 3 4 5 6 7 8

TOP COVE
385MM*290MM*30MM

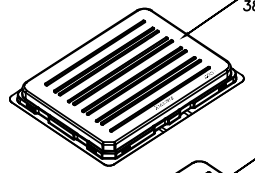

TRAY
380MM*285MM*30MM

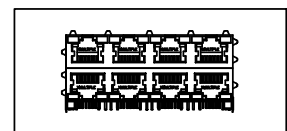
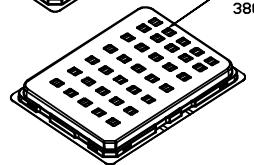

ROHS TRAY LABEL

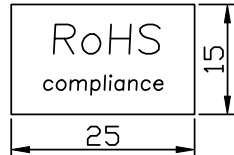

ROHS CARTON LABEL

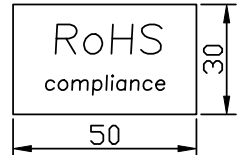

TRAY LABEL:

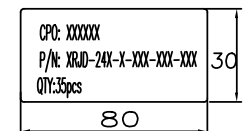

CARTON LABEL:

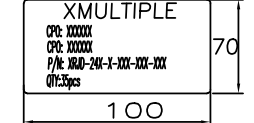

ROHS LABEL(LEFT) INNER LABEL(RIGHT)

DET A

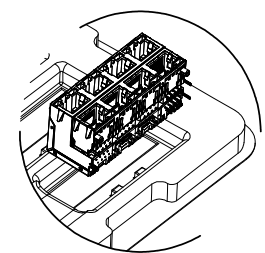

CARD BOARD X 1
410MM*310MM*5.6MM

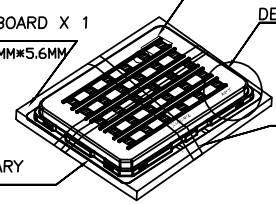

PACKING STRAP X 3

35PCS/TARY

CARTON/175PCS

425MM*325MM*210MM

PACKING STRAP X 3

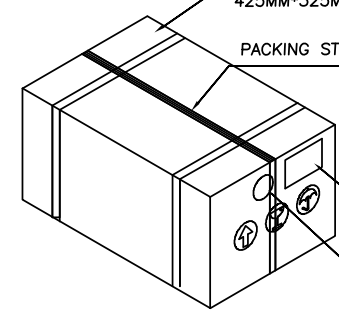

PACKING LABEL

ROHS LABEL

PE BAG
100MM*70MM*0.08MM

5 TRAY/175PCS

DESICCANT
2 PCS

CARD BOARD X6
410MM*310MM*5.6MM

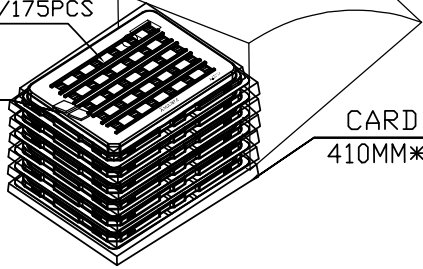

<h1>XMULTIPLE</h1>			CONNECTING THE INFORMATION AGE	
XMULTIPLE ASIA 4F, No. 347, Yang Guang St., Neihu, Taipei, Taiwan 11475		XMULTIPLE USA 1420 Los Angeles Ave., Suite G, Simi Valley, CA 93065		G/NO:
THIS DRAWING IS A CONTROLLED DOCUMENT.				DWG NO: A
TITLE: XRJD-24X PORT PACKING				DRAWN: KEN
PART NO:				CHKD: CP
UNIT mm[inch]		SHEET 1 of 1		REV 03
				DATE: Oct.15,09

1 2 3 4 5 6 7 8