

NOTED:

1. Material:

1.1 CAGE ASSEMBLY: COPPER ALLOY

1.2 GASKET RETENTION PLATE: STAINLESS STEEL

1.3 EMI GASKET: CONDUCTIVE ELASTOMER

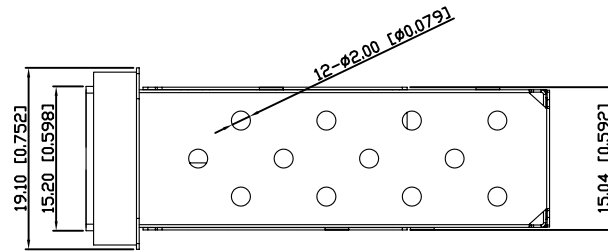

XSFP-A-PPFC-0101-MA

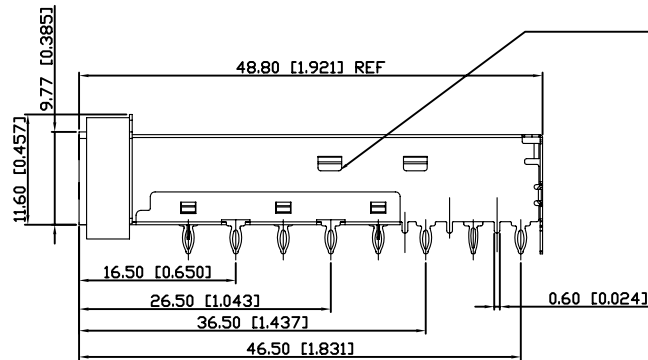
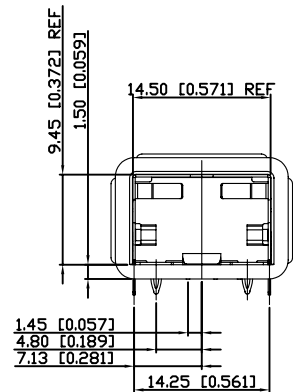
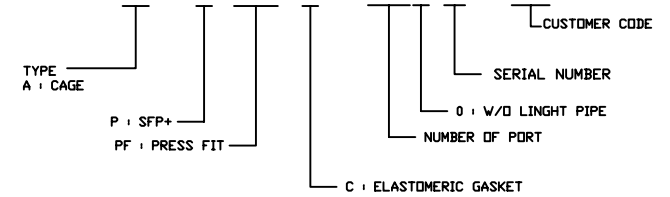

RoHS Compliant

<b>X MULTIPLE</b>		CONNECTING THE INFORMATION AGE	
XMULTIPLE ASIA 4F, No. 347, Yang Guang St., Neihu, Taipei, Taiwan 11475		XMULTIPLE USA 1420 Los Angeles Ave., Suite G, Simi Valley, CA 93065	
THIS DRAWING IS A CONTROLLED DOCUMENT.		G/NO: DVG NO: XSFP-A-PPFC-0101-MA	
TITLE: SFP+(PLUS) CAGE : 1 PORT WITH ELASTOMERIC GASKET, PRESS FIT PINS		DRAWN: IVAN	
PART NO: XSFP-A-PPFC-0101-MA		CHKD: TARA	
		UNIT mm [inch]	SHEET 1 of 2
		REV 01	DATE: Dec.16,08

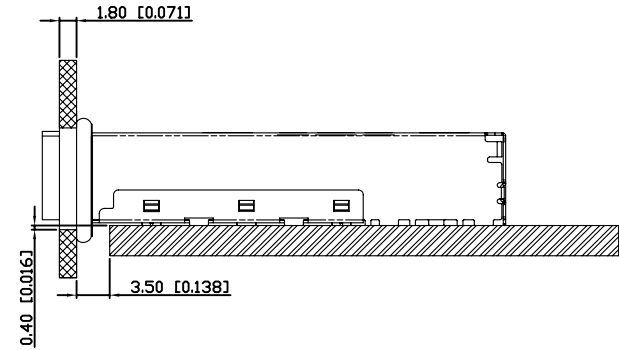
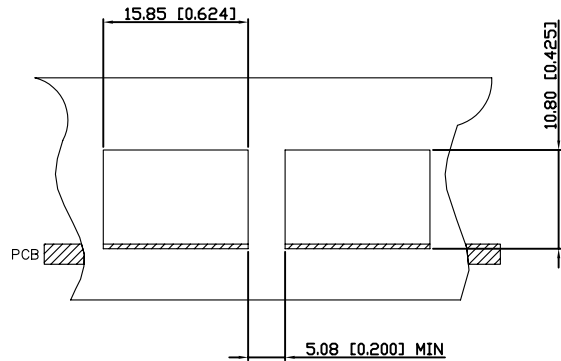

TOP OF PCB TO INSIDS OF BEZEL CUT-OUT

CROSS-HATCHED AREA DENOTES COMPONENT AND TRACE KEEP-OUT (EXCEPT CHASSIS GROUND)

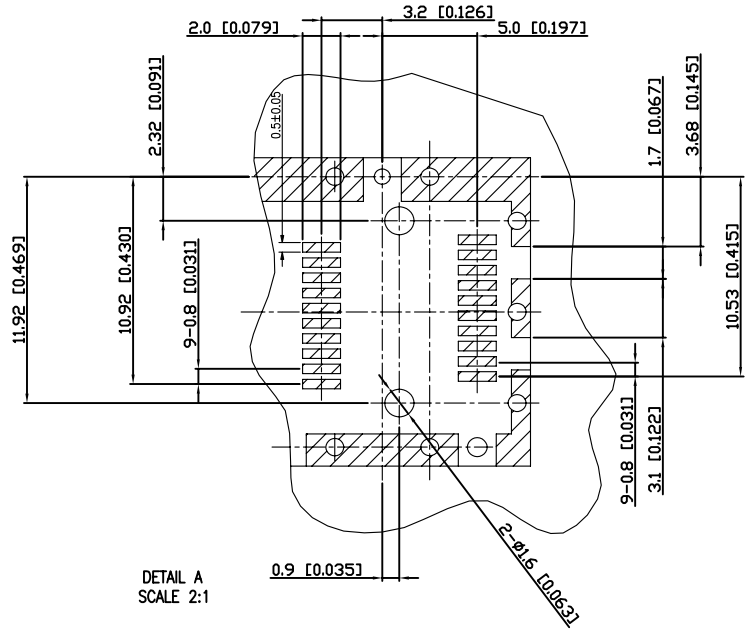
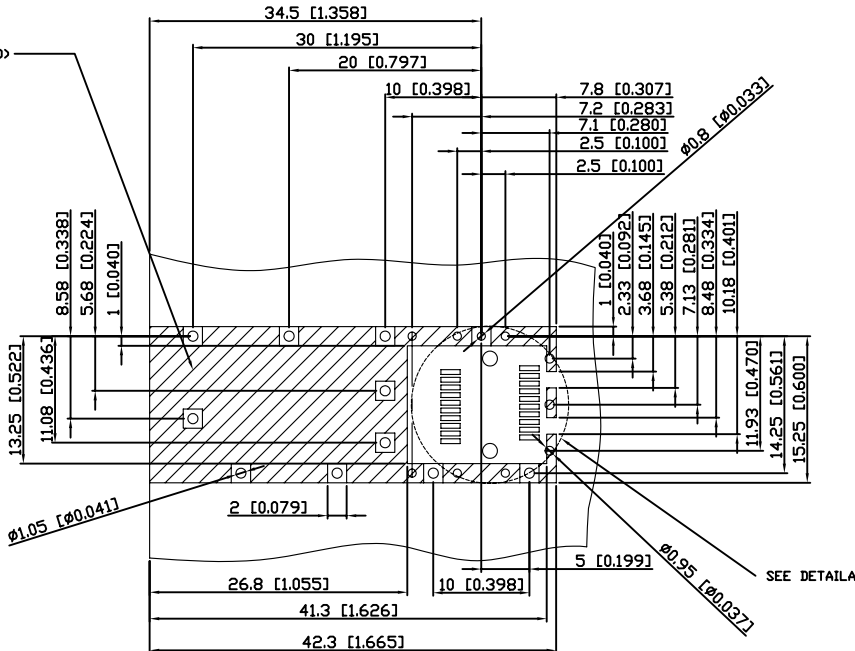

DETAIL A SCALE 2:1

RoHS Compliant

<b>X MULTIPLE</b>		CONNECTING THE INFORMATION AGE	
XMULTIPLE ASIA 4F, No. 347, Yang Guang St., Neihu, Taipei, Taiwan 11475		XMULTIPLE USA 1420 Los Angeles Ave., Suite G, Simi Valley, CA 93065	
THIS DRAWING IS A CONTROLLED DOCUMENT.		G/NO:	
TITLE: SFP+(PLUS) CAGE 1 PORT WITH ELASTOMERIC GASKET, PRESS FIT PINS		DWG NO: XSFP-A-PPFC-0101-MA	
PART NO: XSFP-A-PPFC-0101-MA		DRAWN: IVAN	
		CHKD: TARA	
UNIT: mm [inch]		SHEET: 2 of 2	
REV: 01		DATE: Dec.16,08	