

1. MECHANICAL DIMENSIONS :

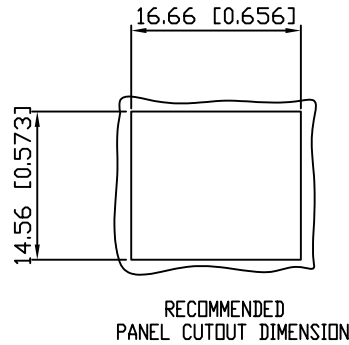

NOTES:

- MATERIALS:
HOUSING: PBT POLYESTER UL94V-0
MIXED GLASS FIBER.
STANDARD COLOR-BLACK.
CONTACTS: 0.35mm THICK PHOS-BRONZE PLATED
WITH 15u" GOLD AND TIN
IN SOLDER AREA.
SHIELD: 0.25mm THICK COPPER ALLOY,
PLATED WITH NICKEL.
- OPERATING TEMPERATURE: 0°C ~ +70°C
- CAVITY CONFORMS TO FCC RULES AND REGULATIONS
PART 68, SUBPART F.
- UNSPECIFIED TOLERANCE: .XX ±0.25[0.010]
.X ±0.30[0.012]

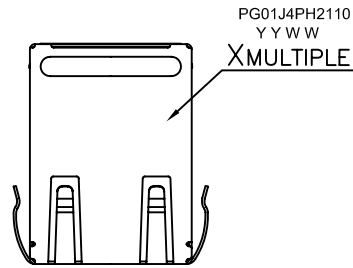
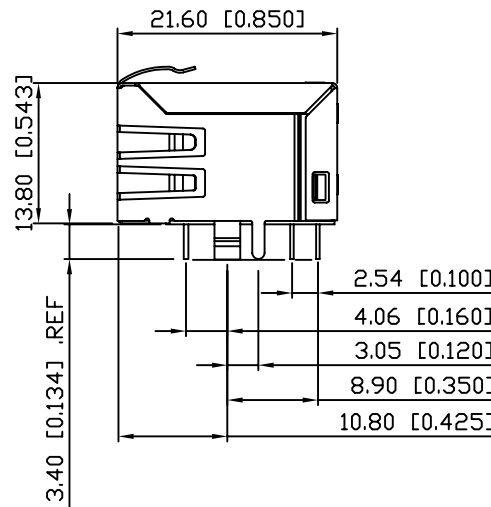
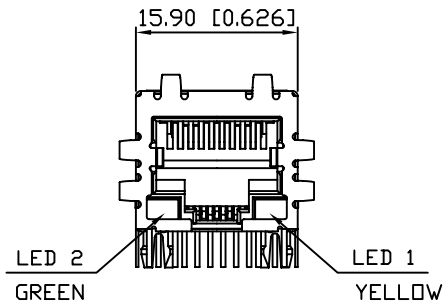

RECOMMENED PLUG DIMENSION:

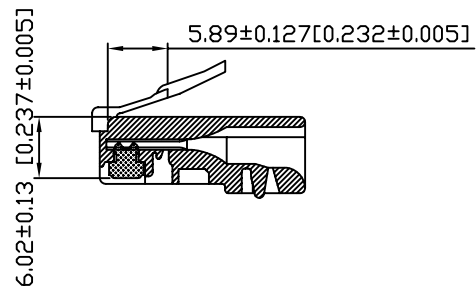

RoHS Compliant

THIS DRAWING IS A CONTROLLED DOCUMENT.			
TITLE: SINGLE PORT, RJ45, SHIELDED, WITH LED WITH TRANSFORMER, SIDE ENTRY PCB JACK, FOR PoE		G/NO: DWG NO: XPJG-01J-4-PH2-110	
PART NO: XPJG-01J-4-PH2-110		DRAWN: RUNES	
		UNIT mm[Inch]	SHEET 1 of 3
DATE: May.16,08		REV 01	CHKD: TARA

2. PCB LAYOUT :

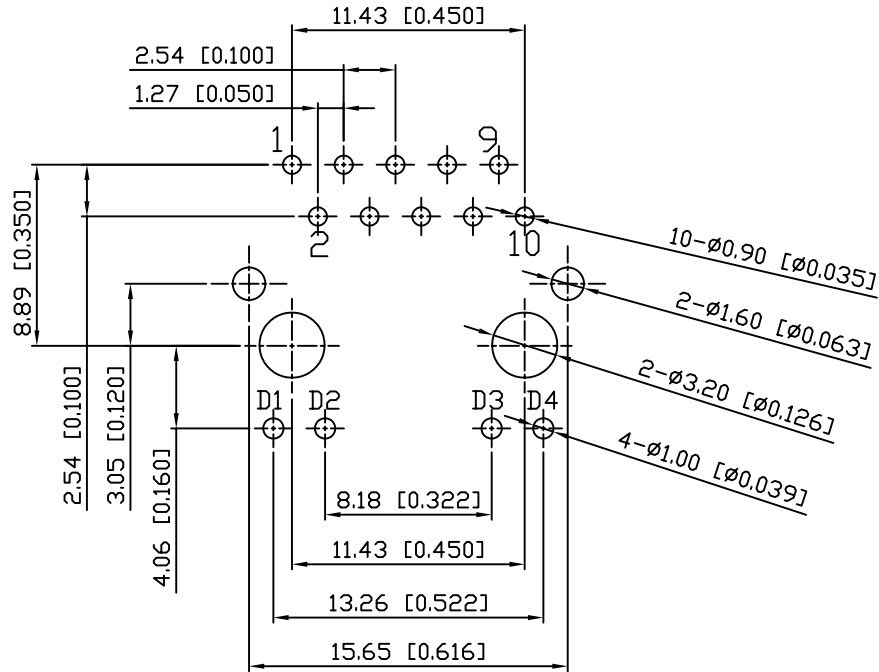

SUGGESTED PCB LAYOUT
(TOP VIEW)

DIMENSIONAL TOLERANCE: .XX ±0.08[0.003]

3. LED CONFIGURATION :

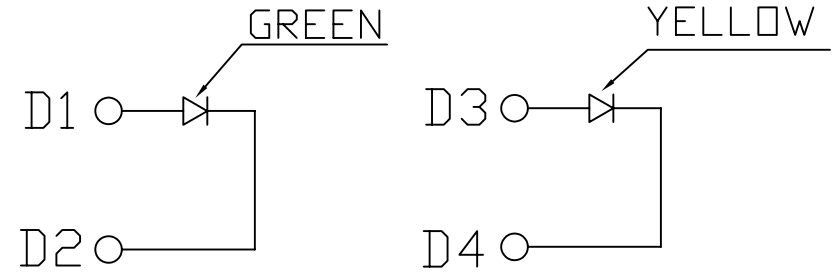

RoHS Compliant

		CONNECTING THE INFORMATION AGE		
				XMULTIPLE ASIA 4F, No. 347, Yang Guang St., Neihu, Taipei, Taiwan 11475
THIS DRAWING IS A CONTROLLED DOCUMENT.				DWG NO: XPJG-01J-4-PH2-110
TITLE: SINGLE PORT, RJ45, SHIELDED, WITH LED WITH TRANSFORMER, SIDE ENTRY PCB JACK, FOR PoE		DRAWN: RUNES		
PART NO: XPJG-01J-4-PH2-110		CHKD: TARA		
		UNIT mm[Inch]	SHEET 2 of 3	REV 01
				DATE: May.16.08

4. SCHEMATIC:

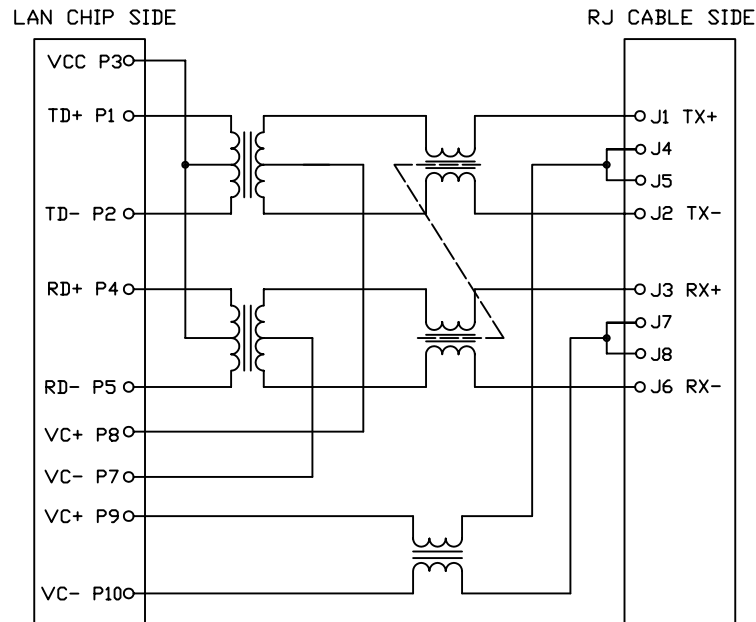

5. ELECTRICAL CHARACTERISTICS :

TEST NOTES:(25±5°C)

1.TR:(100KHz,0.1V);

PINS:(P1-P2):(J1-J2)=1:1±3%

PINS:(P4-P5):(J3-J6)=1:1±3%

2.LX:(100KHz,100mV,8mA, DC Bias)

PINS:(P1,P2),(P4,P5)=350uH MINIMUM

3.DCR:

PINS:(J1,J2),(J3,J6)=1.2 OHMS MAXIMUM

4.HIPOT:

PINS(P1,P3,P2)TO(J1,J2)=1500VAC FOR 60 SECONDS

PINS(P4,P3,P5)TO(J3,J6)=1500VAC FOR 60 SECONDS

5.INSERTION LOSS:

-1.0dB MAXIMUM AT 0.3MHz TO 100MHz;

6.RETURN LOSS:

-20dB MINIMUM AT 1MHz TO 30MHz;

-15dB MINIMUM AT 30MHz TO 60MHz

-10dB MINIMUM AT 60MHz TO 80MHz

7.CROSS TALK:

-30dB MINIMUM AT 1MHz TO 100MHz

8.COMMON TO COMMON MODE REJECTION:

-30dB MINIMUM AT 1MHz TO 100MHz

XPJG-01J-4-PH2-110

PRODUCT SERIES
XPJG : LATCH DOWN WITH LED
FOR PoE TYPE

NUMBER OF PORTS
MECHANICAL TYPE
01J : 1 PORT FOR XRJ45 OR XRJ45
W/HORIZONTAL LED PIN
W/O MODULE

LED COLOR OPTION



SPECIAL CODE
0 : STANDARD

SHIELDED TYPE
1 : Y=3.05mm, EMI FINGER
ON ALL SIDE

LED POLARITY
1 : +-, +-

CIRCUIT TYPE

RoHS Compliant

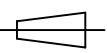
				
				MULTIPLE ASIA 4F, No. 347, Yang Guang St., Neihu, Taipei, Taiwan 11475
THIS DRAWING IS A CONTROLLED DOCUMENT.				G/NO:
TITLE: SINGLE PORT, RJ45, SHIELDED, WITH LED WITH TRANSFORMER, SIDE ENTRY PCB JACK, FOR PoE			DWG NO: XPJG-01J-4-PH2-110	
PART NO: XPJG-01J-4-PH2-110			DRAWN: RUNES	
			UNIT mm[Inch]	SHEET 3 of 3
			REV 01	DATE: May.16,08